

SCALE 1 / 4

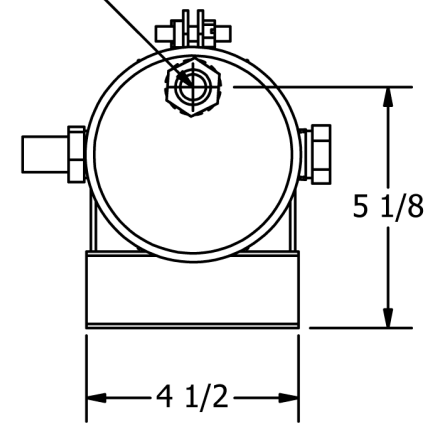
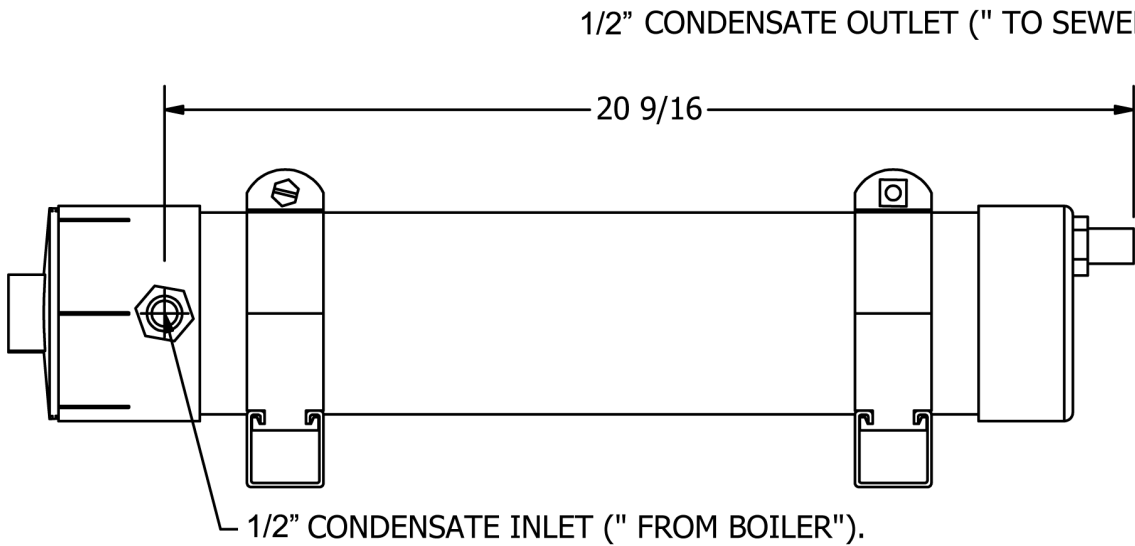

NOTE:

ALL DIMENSIONS SHOWN ARE APPROXIAMTE AND MAY VARY DUE TO MANUFACTURING PROCESS TOLERANCE.

PH NEUTRALIZER		REVISION #:
2000 MBH , 6 GPH		
DRAWN BY:	PART NO.	
DATE DRAWN:	JM-20	
7/3/2006		